

SERVICE MANUAL

INTEGRATED AMPLIFIER

SANSUI AU-X201/X301



CAUTION

1. Parts identified by the \triangle symbol on the schematic diagram and the parts list are critical for safety. Use only replacement parts that have critical characteristics recommended by the manufacturer.
2. Make leakage-current or resistance measurements to determine that exposed parts are acceptably insulated from the supply circuit before returning the appliance to the customer.

•SPECIFICATIONS

<AU-X201>

Power output

Min. RMS, both channels driven, from 20 to 20,000 Hz, with no more than 0.05% total harmonic distortion.
30 watts per channel into 1 kHz, 8 ohms.

Frequency response (at 1 watt)

Overall (from CD)..... 1 to 100,000 Hz, +0 dB
-3 dB

Signal to noise ratio (short-circuit, A-network)

PHONO (MM)..... 75 dB
CD, TUNER, LINE..... 105 dB
TAPE PLAY-1, 2..... 105 dB

Power consumption

150 watts
250 watts Maximum

Weight

7.0 kg (15.4 lbs) net

<AU-X301>

Power output

Min. RMS, both channels driven, from 20 to 20,000 Hz, with no more than 0.05% total harmonic distortion.
65 watts per channel into 1 kHz, 8 ohms.

Frequency response (at 1 watt)

Overall (from CD)..... 1 to 150,000 Hz, +0 dB
-3 dB

Signal to noise ratio (short-circuit, A-network)

PHONO (MC)..... 65 dB
PHONO (MM)..... 80 dB
CD, TUNER, LINE..... 105 dB
TAPE PLAY-1, 2..... 105 dB

Power consumption

330 watts 410 VA Rated
460 watts Maximum

Weight

9.5 kg (20.9 lbs) net
11.0 kg (24.3 lbs) packed

<AU-X201/301>

Load impedance

4 to 16 ohms

Total harmonic distortion

less than 0.05% at or below rated min. RMS power output

Intermodulation distortion

(60 Hz: 7 kHz=4:1 SMPTE method)

less than 0.05% at rated power output

RIAA curve deviation (PHONO-MM, 20 Hz to 20 kHz)

+0.5 dB, -0.5 dB

Input sensitivity and impedance (at 1 kHz)

PHONO (MC)..... 420 μ V/100 or 22 ohms (AU-X301 only)

PHONO (MM)..... 3.5 mV/47 kohms

(Max. input capability: 150 mV at 1 kHz, less than 0.1% total harmonic distortion)

CD, TUNER, LINE..... 200 mV/47 kohms

TAPE PLAY-1, 2..... 200 mV/47 kohms

Output level (at 1 kHz)

TAPE REC-1, 2..... 200 mV into 47 kohms

Controls and Filter

BASS..... \pm 8 dB at 50 Hz

TREBLE..... \pm 8 dB at 10 kHz

SUBSONIC..... -3 dB at 16 Hz (6 dB/oct)

LOUDNESS..... +8 dB at 50 Hz

(VOLUME: -30 dB position)

..... +4 dB at 10 kHz

Power requirements

AC 120V/220V/240V,
50/60 Hz

For U.S.A. & Canada AC 120V, 60 Hz

Dimensions

448 mm (17-11/16") W

136 mm (5-3/8") H

311 mm (12-1/4") D

* Design and specifications subject to changes without notice for improvements.

* Due to local laws and regulations, this unit sold in some areas are not equipped with variable voltage selectors.

Sansui

SANSUI ELECTRIC CO., LTD.

NOTE

1. The symbols, UL, CSA, SA, BS, UK, EU, AS, SS, XX <EXPORT> and XX-V <EXPORT(V)> on the parts list and the schematic diagram mean followings respectively.
 - UL..... Manufactured for U.S.A market.
(Underwriters Laboratories approved model.)
 - CSA Manufactured for Canadian market.
 - SA..... Manufactured for South African market.
 - BS, UK..... Manufactured for United Kingdom market.
 - EU Manufactured for European market.
 - AS..... Manufactured for Australian market.
 - SEV Manufactured for Swiss Market.
 - SS..... Manufactured for Saudi Arabia market.
 - XX <EXPORT> Standard Version with Inner Voltage Selector.
 - XX-V <EXPORT(V)> .. Standard Version with Outer Voltage Selector.
 - NON MARK Common Parts.

2. Some printed circuit boards are not supplied assembled. To separate these in this service manual, the stock numbers are not indicated for these boards. However, stock numbers for individual parts are indicated.

3. Since some capacitors and resistors are omitted from parts lists in this service manual, refer to the Common Parts List for capacitors and resistors, which was issued on March 1987.

4. Abbreviations in this service manual are as follows.

•Abbreviations List

C.R. : Carbon Resistor	E.B.L. : Low Leak Bi-Polar Electrolytic Capacitor
S.R. : Solid Resistor	Ta.C. : Tantalum Capacitor
Ce.R. : Cement Resistor	F.C. : Film Capacitor
M.R. : Metal Film Resistor	M.P. : Metalized Paper Capacitor
F.R. : Fusing Resistor	P.C. : Polystyrene Capacitor
N.I.R. : Non-Inflammable Resistor	G.C. : Gimmic Capacitor
A.R. : Array Resistor	A.C. : Array Capacitor
C.C. : Ceramic Capacitor	V.R. : Variable Resistor
C.T. : Ceramic Capacitor, Temperature Compensation	S.V.R. : Semi Variable Resistor
E.C. : Electrolytic Capacitor	SW. : Switch
E.L. : Low Leak Electrolytic Capacitor	Chip R. : Chip Resistor
E.B. : Bi-Polar Electrolytic Capacitor	Chip C. : Chip Capacitor

1. BLOCK DIAGRAM

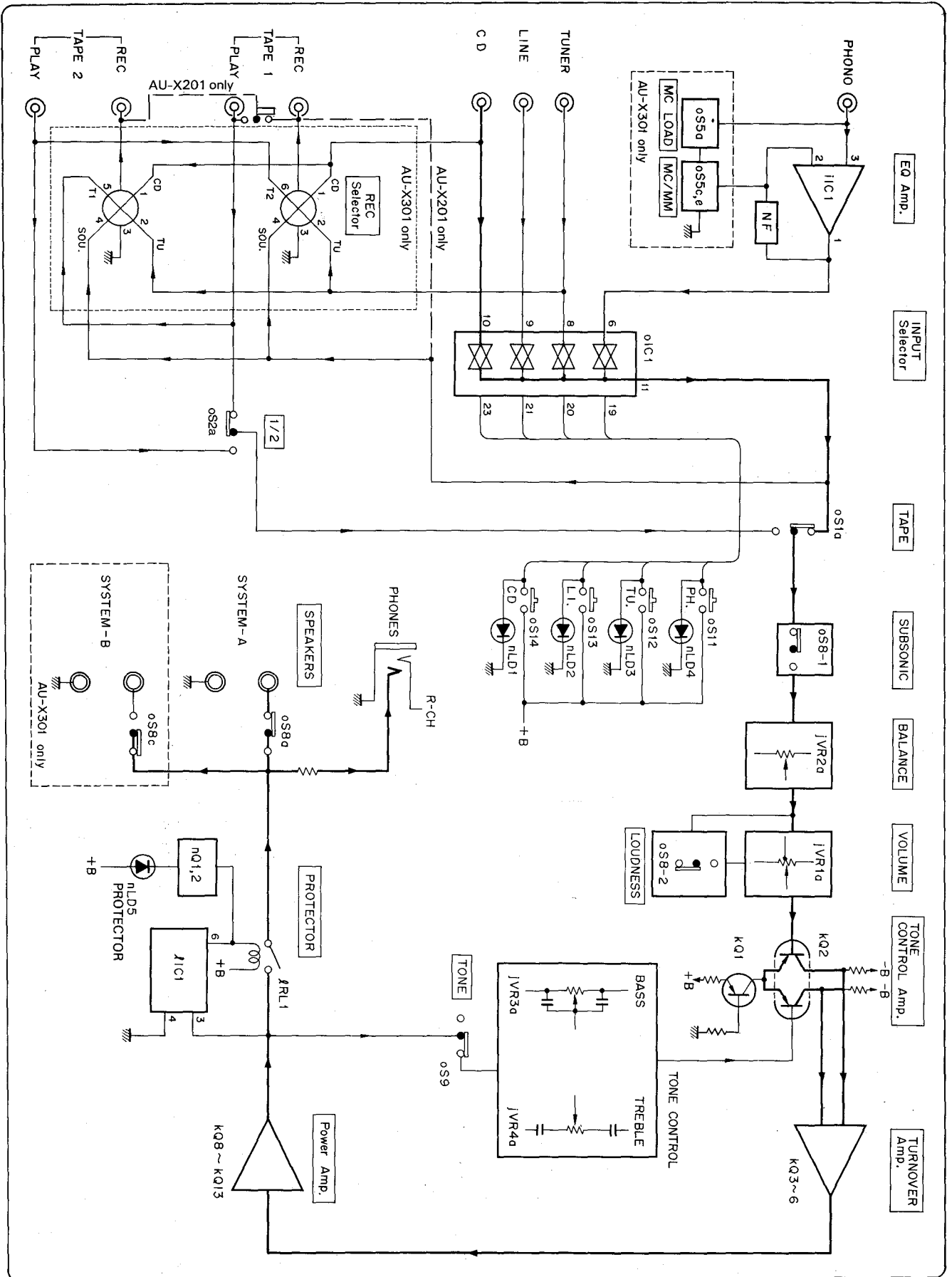

2. ELECTRIC PARTS LIST OF BOARD

2-1. F-5716 Tone Control V.R. Board

(Stock No. 01049601 = AU-X201/01048501 = AU-X301)

Parts No.	Stock No.	Description
jC1	48103000	0.22 μ F 50V E.B.
jC5	48103000	0.22 μ F 50V E.B.
jVR1	83005400	150k Ω (B) V.R., VOLUME
jVR2	83003200	250KMN V.R., BALANCE
jVR3	83003100	50k Ω (C) V.R., BASS
jVR4	83003100	50k Ω (C) V.R., TREBLE
nLD1	48849300	SEL3913K, CD
nLD2	48849300	SEL3913K, LINE
nLD3	48849300	SEL3913K, TUNER
nLD4	48849300	SEL3913K, PHONO
oS1	48837500	Push SW., TAPE
oS2	48837500	Push SW., 1/2 (AU-X301)
	48837300	Push SW., 1/2 (AU-X201)
oS8	83032000	Push SW., SUBSONIC-LOUDNESS
oS9	83002800	Push SW., TONE

2-2. F-5718 PROTECTOR Ind. Board

Parts No.	Stock No.	Description
nLD5	48866300	AY2222S

2-3. F-5719 PHONES Jack Board

Parts No.	Stock No.	Description
oJ1	83002600	Jack,

2-4. F-5720 SPEAKERS Switch Board

Parts No.	Stock No.	Description
Δ kR35	46624700	220 Ω 2W N.I.R. (AU-X301)
Δ	46249700	220 Ω 1W N.I.R. (AU-X201)
oS7	48837200	Push SW., SPEAKERS (AU-X301)
	83005200	Push SW., SPEAKERS (AU-X201)

2-5. F-5721 SPEAKERS Terminal Board (AU-X301)

Parts No.	Stock No.	Description
oZ4	48569100	8P Terminal, Speaker

2-6. F-5723 SPEAKERS Terminal Board (AU-X201)

Parts No.	Stock No.	Description
oZ4	48699700	4P Terminal, Speaker

2-7. F-5717 Power Amp. Board

(Stock No. 01049701 = AU-X201/01048601 = AU-X301)

Parts No.	Stock No.	Description
•Transistor		
kQ1	07299601	2SA1115
	or 46392201	2SA1175
kQ2	48577701	2SA1349
kQ3	46728301	2SC2705
	or 48113001	2SC2229
kQ4	46728301	2SC2705
	or 48113001	2SC2229
kQ5	03064001	2SC1904
	or 46128101	2SC2911
kQ6	03007901	2SA899
	or 46128001	2SA1209
Δ kQ7	03067401	2SC1845
kQ8	48061801	2SC3244
kQ9	48064001	2SA1284
kQ10	46728901	2SC3298 (AU-X301)
	or 48158701	2SC2591 (AU-X301)
	07206401	2SD600K (AU-X201)
kQ11	46728801	2SA1306 (AU-X301)
	or 48158601	2SA1111 (AU-X301)
	07206301	2SB631K (AU-X201)
Δ kQ12	48844201	2SC3856 (AU-X301)
Δ	48844401	2SC3854 (AU-X201)
Δ kQ13	48844101	2SA1492 (AU-X301)
Δ	48844301	2SA1490 (AU-X201)
•Diode		
kD1	83000100	1N4148
Δ kR13	46230200	1k Ω 1/2W N.I.R. (AU-X301)
Δ	46229800	470 Ω 1/2W N.I.R. (AU-X201)
Δ kR14	46229100	120 Ω 1/2W N.I.R. (AU-X301)
Δ	46228700	56 Ω 1/2W N.I.R. (AU-X201)
Δ kR15	46230200	1k Ω 1/2W N.I.R. (AU-X301)
Δ	46229800	470 Ω 1/2W N.I.R. (AU-X201)
Δ kR16	46230200	1k Ω 1/2W N.I.R. (AU-X301)
Δ	46229800	470 Ω 1/2W N.I.R. (AU-X201)
Δ kR17	46230200	1k Ω 1/2W N.I.R. (AU-X301)
Δ	46229800	470 Ω 1/2W N.I.R. (AU-X201)
Δ kR18	46229100	120 Ω 1/2W N.I.R. (AU-X301)
Δ	46228700	56 Ω 1/2W N.I.R. (AU-X201)
Δ kR22	46228200	33 Ω 1/2W N.I.R.
Δ kR23	46228200	33 Ω 1/2W N.I.R.
Δ kR28	46230200	1k Ω 1/2W N.I.R.
Δ kR29	46229100	120 Ω 1/2W N.I.R.
Δ kR30	46227400	4.7 Ω 1/2W N.I.R.
Δ kR31	46227400	4.7 Ω 1/2W N.I.R.
Δ kR32	83013200	0.22 Ω 5W Ce.R.
Δ kR33	46623100	10 Ω 2W N.I.R. (AU-X301)
Δ	46248100	10 Ω 1W N.I.R. (AU-X201)
Δ kR34	46247300	2.2 Ω 1W N.I.R. (AU-X301)
Δ	46227000	2.2 Ω 1/2W N.I.R. (AU-X201)
Δ kR38	83013200	0.22 Ω 5W Ce.R.
KL1	46851900	Inductor 0.8 μ H
	or 83020100	Inductor 0.8 μ H
kVR1	83006900	1k Ω S.V.R., Bias
•Transistor		
IQ1	46581701	2SC1845
IQ2	46581601	2SA992
•IC		
Δ IIC1	46207600	TA7317P
•Diode		
ID1	83000100	1N4148
ID2	83000100	1N4148
ID3	83024700	1N4003

2-9. F-5751 EQ Amp. INPUT Terminal Board
(Stock No. 01050401 = AU-X201/01049301 = AU-X301)

Parts No.	Stock No.	Description
ID4	83024700	1N4003
ID5	83005000	1N4002
△ IR18	46229900	560Ω 1/2W N.I.R. (AU-X301)
△	46229500	270Ω 1/2W N.I.R. (AU-X201)
IC5	48104200	220μF 6.3V E.B.
IRL1	46254900	Relay, AP24D2
• Transistor		
nQ1	03067401	2SC1845
nQ2	03067401	2SC1845
• Diode		
nD1	83000100	1N4148

2-8. F-5722 Power Supply Board
(Stock No. 01050201 = AU-X201/01049101 = AU-X301)

Parts No.	Stock No.	Description
• Transistor		
△ mQ1	48061801	2SC3244
△ mQ2	48064001	2SA1284
• Diode		
△ mD1	83002000	KBU6D (AU-X301)
△	83002100	KBU4D (AU-X201)
△ mD2	83020200	DF04M
• Zener Diode		
mDZ1	46114400	05Z15-X
	or 46114500	05Z15-Y
	or 46114600	05Z15-Z
	or 46828000	RD15E-B1
	or 46828100	RD15E-B2
mDZ2	46114400	05Z15-X
	or 46114500	05Z15-Y
	or 46114600	05Z15-Z
	or 46828000	RD15E-B1
	or 46828100	RD15E-B2
△ mR12	46623100	10Ω 2W N.I.R.
mC1	48913300	8200μF 63V E.C. (AU-X301)
	48913400	6800μF 42V E.C. (AU-X201)
mC2	48913300	8200μF 63V E.C. (AU-X301)
	48913400	6800μF 42V E.C. (AU-X201)
mC11	08680400	0.01μF 500V C.C.
mC12	08680400	0.01μF 500V C.C.
△ pC1	46425800	0.01μF 400V C.C.
△	or 46943200	0.01μF 400V C.C.
△ pF1	83021900	Fuse 3A for AU-X301 (XX-V•SS)
△	83021600	Fuse 1.5A for AU-X201 (XX-V•SS)
△	83022200	Fuse 6A for AU-X301 (UL•CSA)
△	83024000	Fuse 3.15A for AU-X301 (EU•UK•SEV)
△	83023600	Fuse 1.25A for AU-X201 (EU•UK•SEV)
△ pF2	83021900	Fuse 3A for AU-X301 (XX-V•SS)
△	83021600	Fuse 1.5A for AU-X201 (XX-V•SS)
△	83023100	Fuse 400mA (SEV)
△ pS1	48844500	Push SW., POWER

Parts No.	Stock No.	Description
• IC		
iIC1	46288800	M5220L (AU-X301)
	46147700	M5218L (AU-X201)
oIC1	48570700	TC9152P
• Diode		
oD1	83000100	1N4148
oD2	83024700	1N4003
• Zener Diode		
oDZ1	46109000	05Z2.7-X
	or 46109100	05Z2.7-Y
	or 46109200	05Z2.7-Z
	or 46823000	RD2.7E-B1
	or 46823100	RD2.7E-B2
oDZ2	46109000	05Z2.7-X
	or 46109100	05Z2.7-Y
	or 46109200	05Z2.7-Z
	or 46823000	RD2.7E-B1
	or 46823100	RD2.7E-B2
oDZ3	46109000	05Z2.7-X
	or 46109100	05Z2.7-Y
	or 46109200	05Z2.7-Z
	or 46823000	RD2.7E-B1
	or 46823100	RD2.7E-B2
oDZ4	46109000	05Z2.7-X
	or 46109100	05Z2.7-Y
	or 46109200	05Z2.7-Z
	or 46823000	RD2.7E-B1
	or 46823100	RD2.7E-B2
oC12	48575900	5600μF 16V E.C.
oS3	07200200	Slide SW., REC SELECTOR (AU-X301)
oS5	83032100	Push SW., MM/MC•MC LOAD (AU-X301)
oZ1	48528400	2P Terminal, PHONO
oZ3	48528600	6P Terminal, TUNER•LINE•CD

2-10. F-5735 Selector Switch Board

Parts No.	Stock No.	Description
oS11	83003000	Push SW., PHONO
oS12	83003000	Push SW., TUNER
oS13	83003000	Push SW., LINE
oS14	83003000	Push SW., CD

2-11. F-5752 TAPE/DAT Terminal Board

Parts No.	Stock No.	Description
oZ2	48528500	4P Terminal,

3. PARTS LOCATION OF CIRCUIT BOARD

3-1. F-5717 Power Amp. Board

Component Side

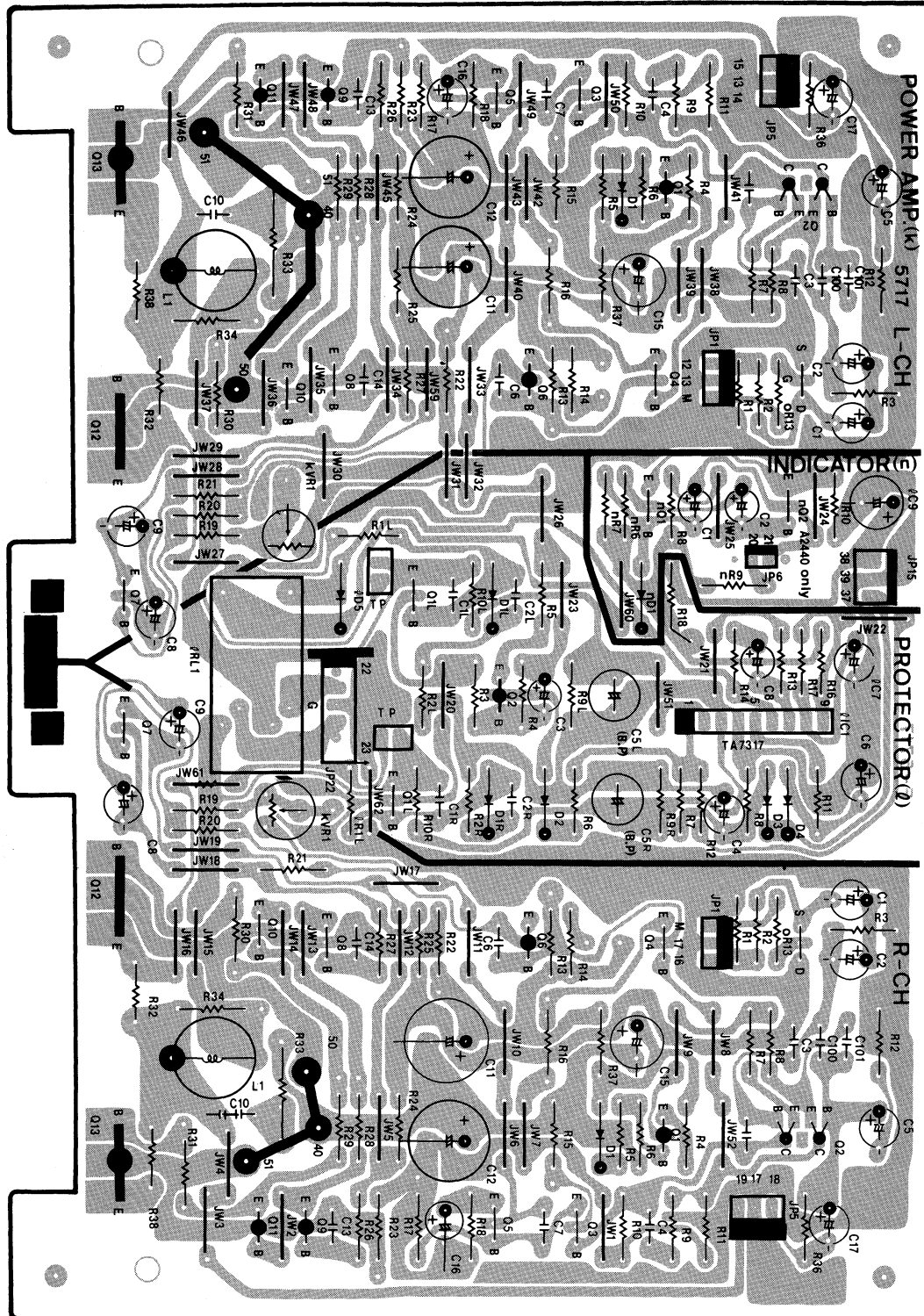

3-2. F-5721 SPEAKERS Terminal Board

Component Side (AU-X301)

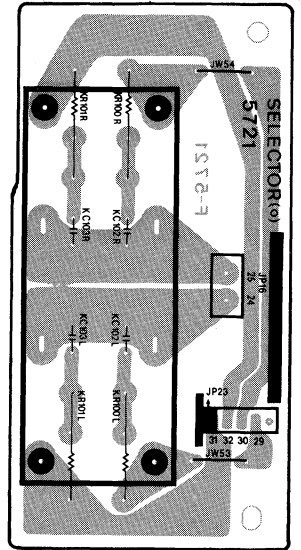

3-3. F-5735 Selector Switch Board

Component Side

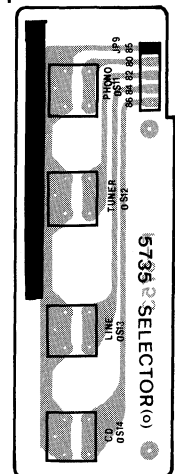

3-4. F-5719 PHONES Jack Board

Component Side

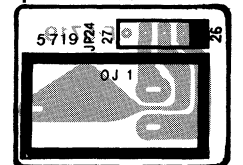

3-5. F-5718 PROTECTOR Ind. Board

Component Side

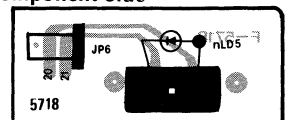

3-6. F-5751 EQ Amp. & INPUT Terminal Board
Component Side

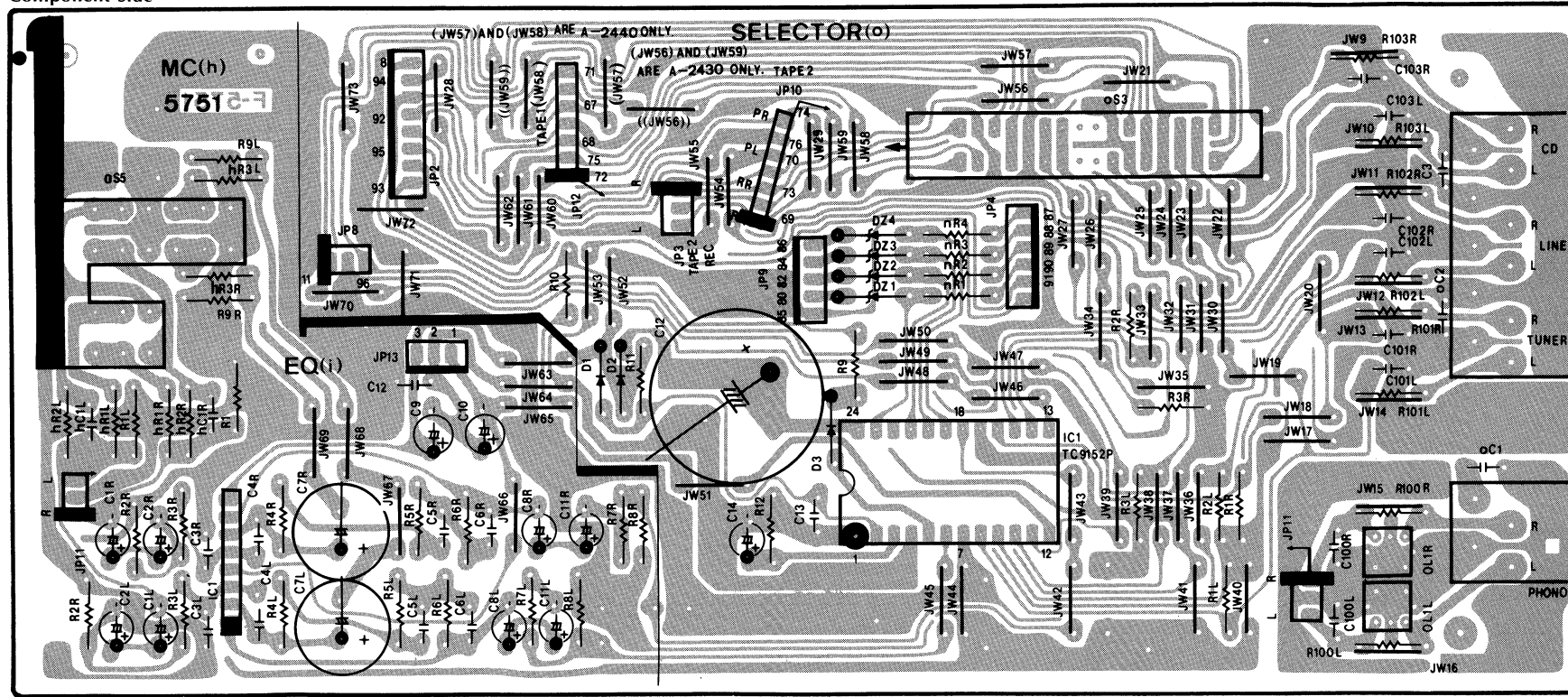

3-8. F-5752 TAPE/DAT
Component Side Terminal Board

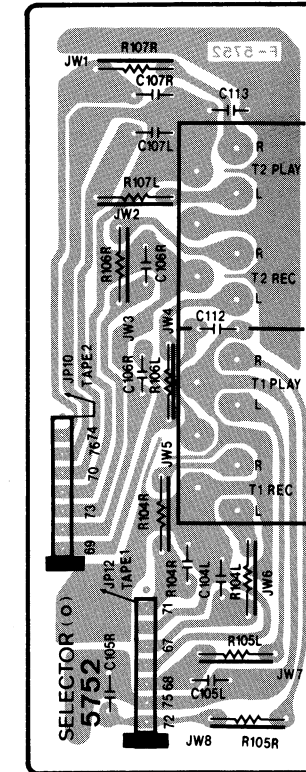

3-9. F-5722 Power Supply Board
Component Side

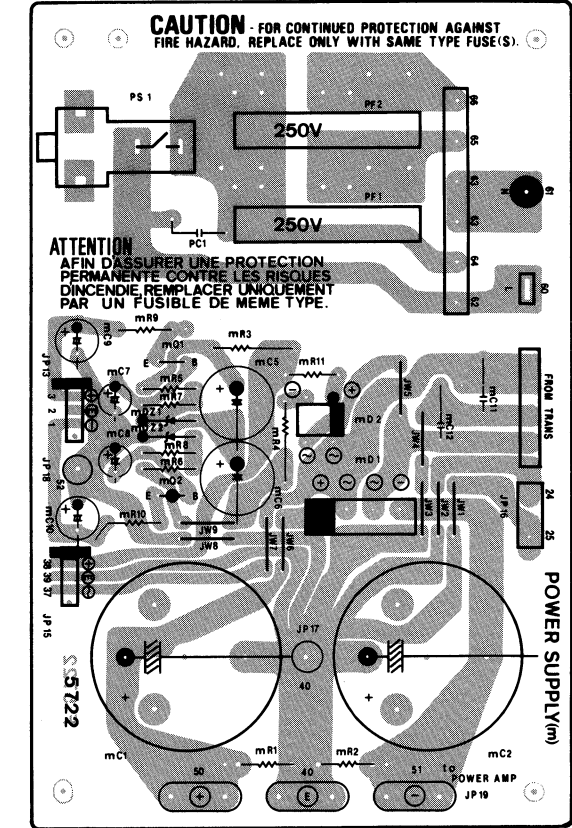

3-7. F-5716 Tone Control Volume Board
Component Side

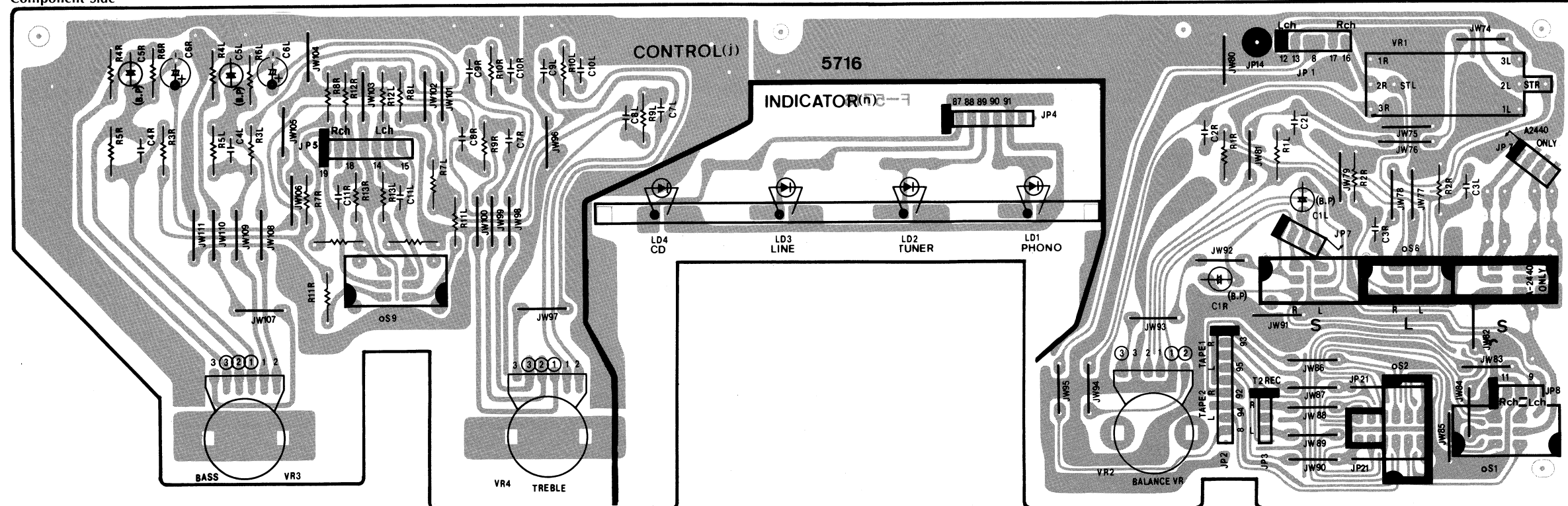

3-10. F-5720 SPEAKERS
Component Side Switch Board

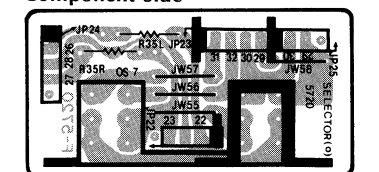

3-11. F-5723 SPEAKERS
Terminal Board (AU-X201)
Component Side

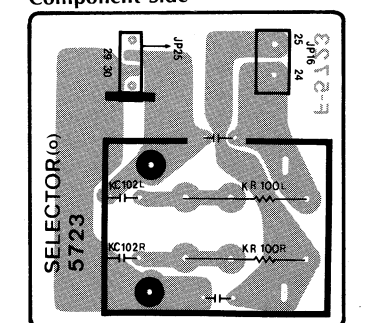

4. OTHER PARTS

• Front View

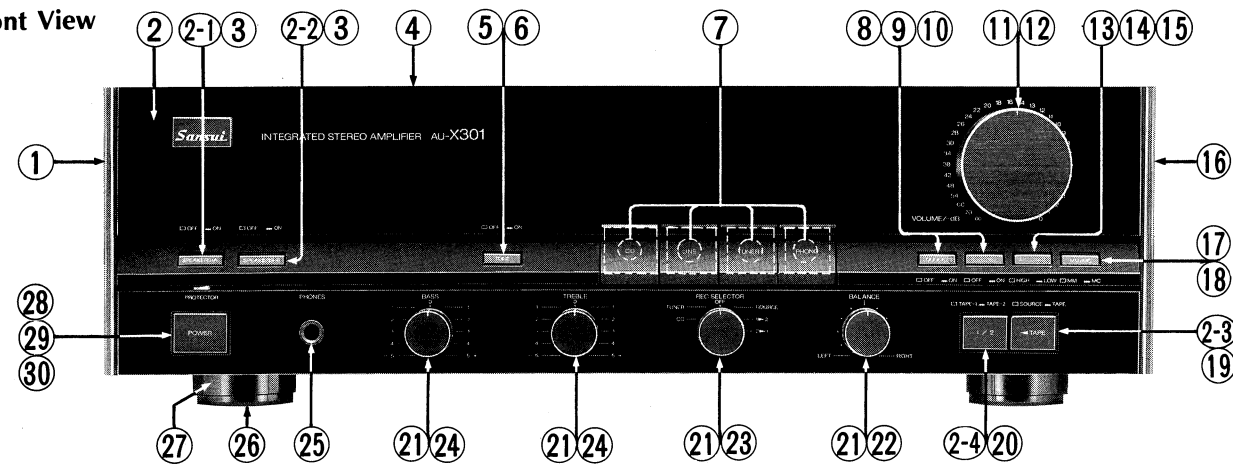

• Top View

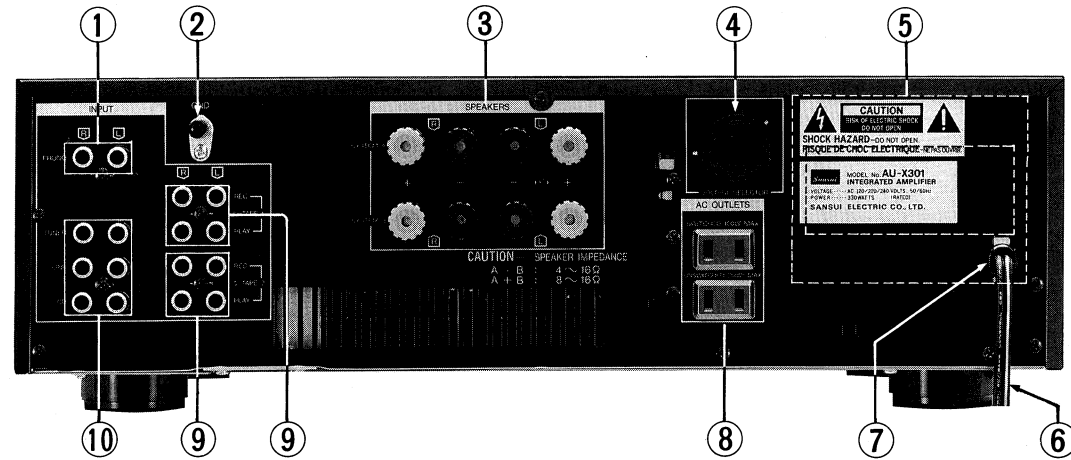

Parts List <Front View>

Parts No.	Stock No.	Description
1	84523000	Left Side Panel
2	37500301	Front Panel Ass'y (AU-X301)
	37500401	Front Panel Ass'y (AU-X201)
2-1	84524500	Knob, SPEAKERS-A (AU-X301)
	84524700	Knob, SPEAKERS (AU-X201)
2-2	84524600	Knob, SPEAKERS-B (AU-X301)
2-3	84525300	Knob, TAPE
2-4	84525400	Knob, 1/2
3	48837200	Push SW., SPEAKERS (AU-X301)
	83005200	Push SW., SPEAKERS (AU-X201)
4	84527200	Bonnet
5	84524800	Knob, TONE
6	83002800	Push SW., TONE
7	83003000	Tact SW., PHONO•TUNER•LINE•CD
8	84524900	Knob, LOUDNESS
9	84525000	Knob, SUBSONIC
10	83032000	Push SW., LOUDNESS•SUBSONIC
11	84525500	Knob, VOLUME
12	83005400	150kΩ V.R., VOLUME
13	84525100	Knob, MC LOAD (AU-X301)
14	84526900	Joint Shaft, MC LOAD (AU-X301)

Parts No.	Stock No.	Description
15	83032100	Push SW., MC LOAD•MM/MC (AU-X301)
16	84523100	Right Side Panel
17	84525200	Knob, MM/MC (AU-X301)
18	84527000	Joint Shaft, MM/MC (AU-X301)
19	48837500	Push SW., TAPE
20	48837500	Push SW., 1/2 (AU-X301)
	48837300	Push SW., 1/2 (AU-X201)
21	84525600	Knob, BALANCE•REC SELECTOR•TABLE•BASS
22	83003200	250kΩ V.R., BALANCE
23	48837000	Rotary Selector with Flexible wire (AU-X301)
24	83003100	50kΩ V.R., TREBLE•BASS
25	83002600	Jack, PHONES
26	84532000	Rubber for Leg
27	84526700	Leg
28	84524400	Knob, POWER
29	84526800	Joint Sht, POWER
△30	48844500	Push SW., POWER

Parts List <Rear View>

Parts No.	Stock No.	Description
1	48528400	2P Terminal, PHONO
2	22301510	Ground Terminal
3	48569100	8P Terminal, SPEAKERS (AU-X301)
	48699700	4P Terminal, SPEAKERS (AU-X201)
△4	84175200	Plug, Voltage Selector (XX-V•SS)
△	07204700	Slide SW., Voltage Selector (EU•UK•SEV)
△5	83001509	Power Transformer for AU-X301 (XX-V•SS)
△	83001502	Power Transformer for AU-X301 (UL•CSA)
△	83001505	Power Transformer for AU-X301 (EU•UK•SEV)
△	83001609	Power Transformer for AU-X201 (XX-V•SS)
△	83001605	Power Transformer for AU-X201 (EU•UK•SEV)

Parts No.	Stock No.	Description
6	39104900	Strain Relief (XX-V•UL•CSA)
	48913500	Strain Relief (SS•EU•UK•SEV•CSA)
△7	83003500	Power Supply Cord (XX-V)
△	83003600	Power Supply Cord (XX-V polarized•UL•CSA)
△	48837700	Power Supply Cord (SS)
△	38004300	Power Supply Cord (UK)
△	83000600	Power Supply Cord (EU•SEV)
△8	83004100	AC OUTLET (XX-V•SS)
△	83002200	AC OUTLET (XX-V polarized•UL•CSA)
△	83002500	AC OUTLET (EU•SEV)
△	46364800	AC OUTLET (UK)
9	48528500	4P Terminal, TAPE-1•TAPE-2
10	48528600	6P Terminal, TUNER•LINE•CD

5. ADJUSTMENTS

- Note: 1) Master Volume Minimum
 2) Room Temperature 18°C~28°C (65°F~83°F)
 3) For this adjustment, run the unit for more than 5 minutes after the power is switched ON.

4) Before turning ON power switch, set the kVR1 on F-5717 to center position.

STEP	SUBJECT	MEASURE OUTPUT	ADJUST	ADJUST FOR	REMARKS
1.	Bias Current Adj. <L-ch>	Test Terminal (TP, L-ch), DC Volt Meter	kVR1 <L-ch>	DC 5 ± 2mV	•This bias value is converted from current value to voltage by ohms law.
2.	Bias Current Adj. <R-ch>	Test Terminal (TP, R-ch), DC Volt Meter	kVR1 <R-ch>	DC 5 ± 2mV	

Fig. 5-1 Printed Circuit Board Location and adjustment points.

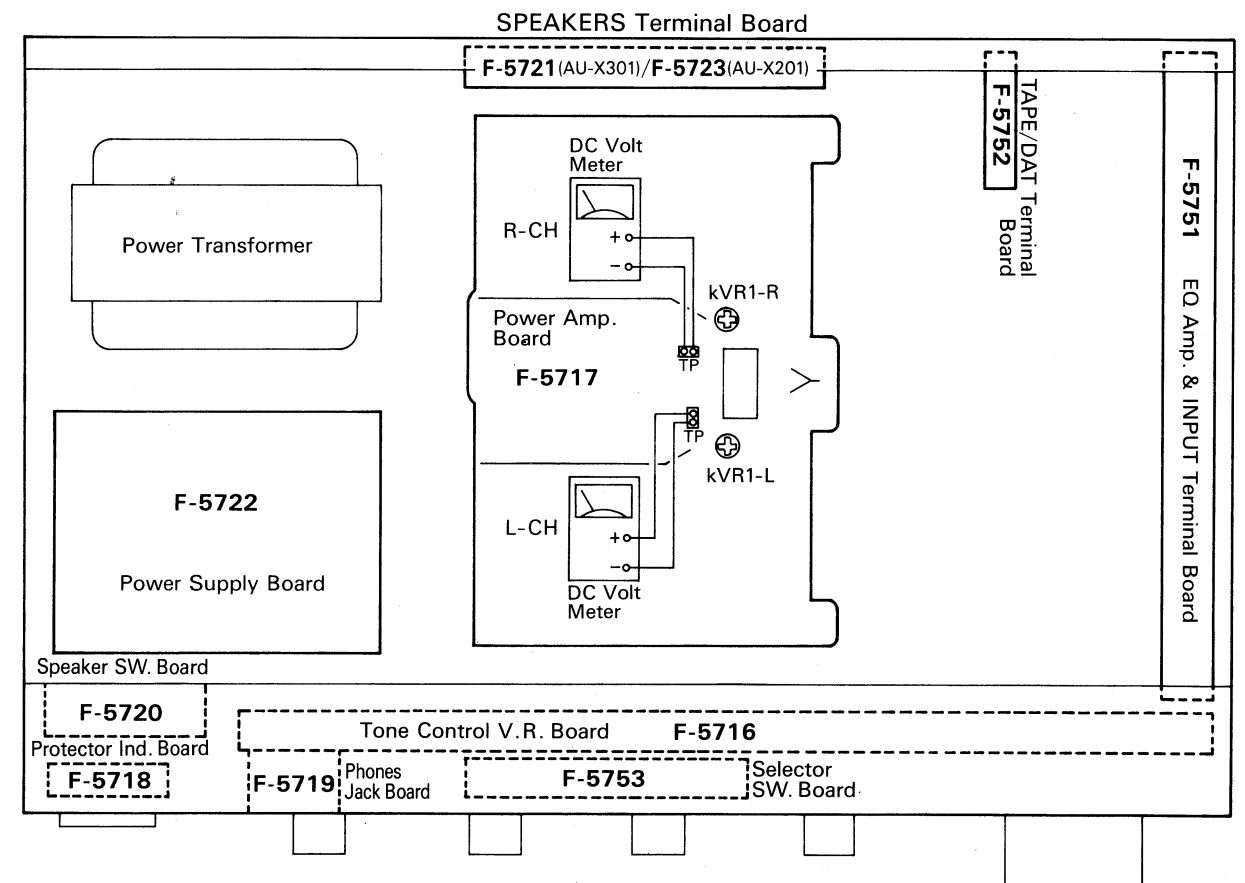

6. SCHEMATIC DIAGRAM

6-1. AU-X201 Main Section

Design and specifications subject to change without notice for improvement.
 La présentation et les spécifications sont susceptibles d'être modifiées sans préavis par suites d'améliorations éventuelles.
 Änderungen, die dem technischen Fortschritt dienen, bleiben vorbehalten.

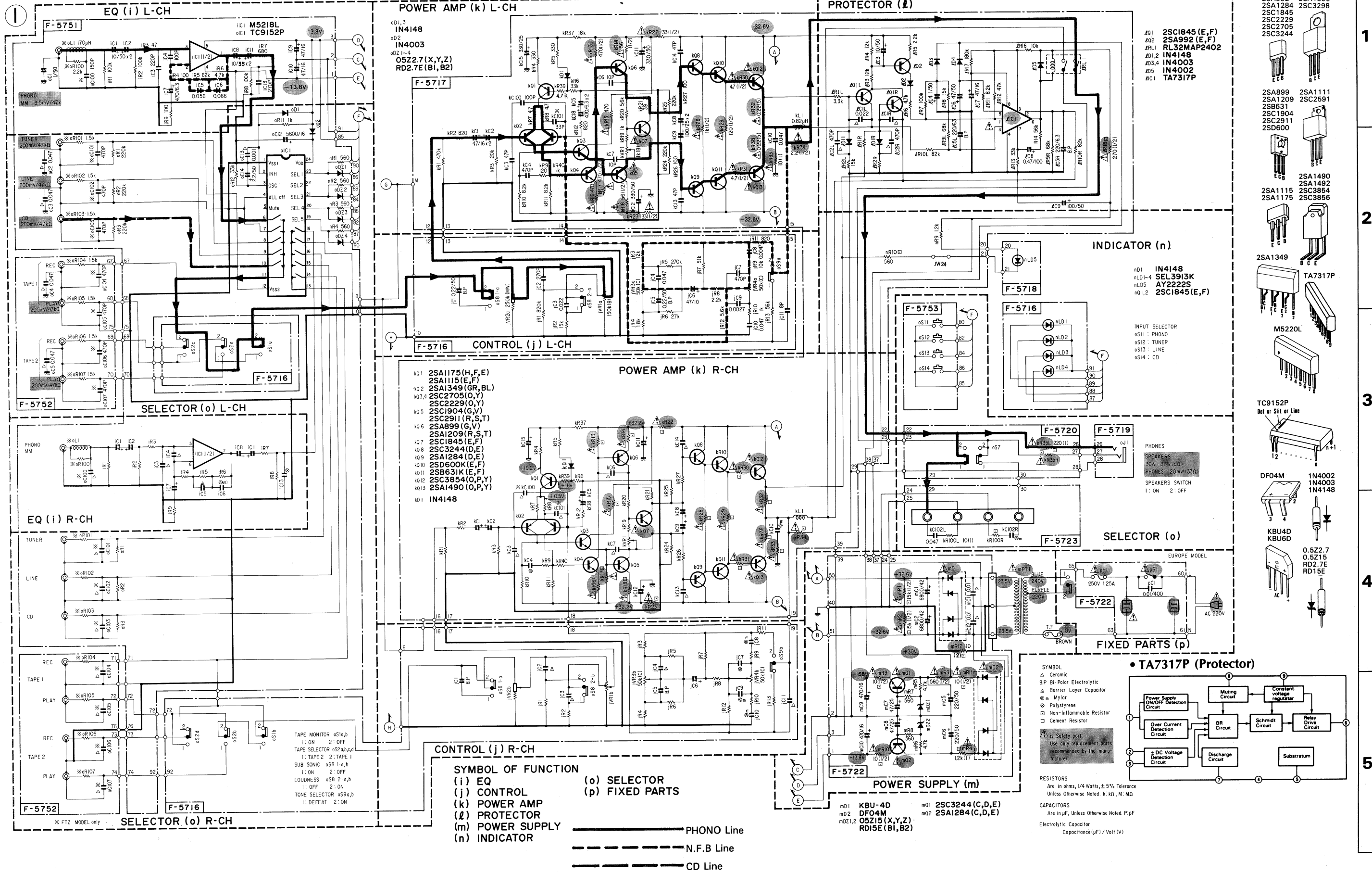

6-2. AU-X301 Main Section

Design and specifications subject to change without notice for improvement.
 La présentation et les spécifications sont susceptibles d'être modifiées sans préavis par suites d'améliorations éventuelles.
 Änderungen, die dem technischen Fortschritt dienen, bleiben vorbehalten.

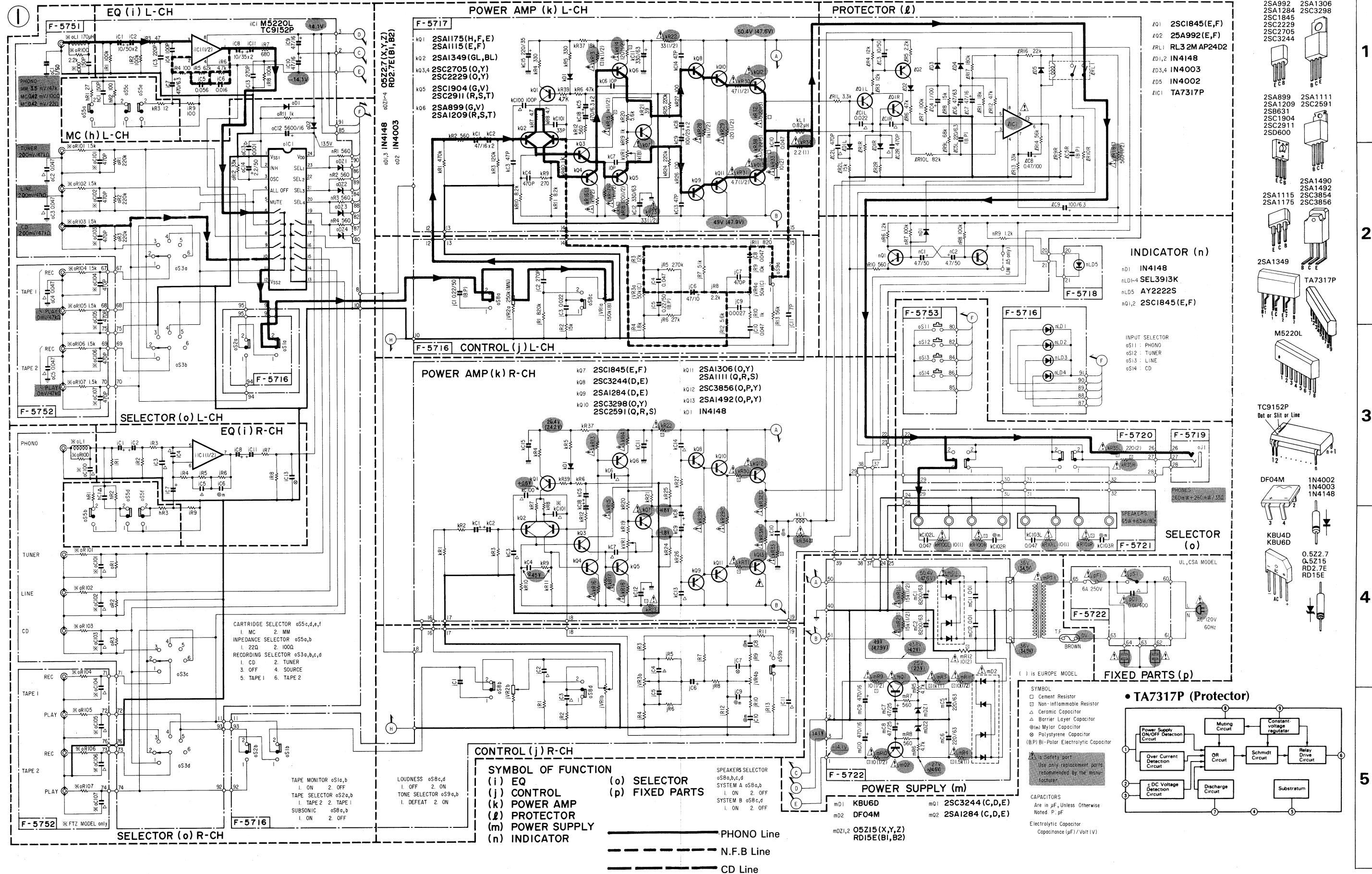

- 2SA992 2SA1306
- 2SA1284 2SC3298
- 2SC1845 2SC2229
- 2SC2705 2SC2705
- 2SC3244 2SC3244
- EQ1 2SC1845(E,F)
- EQ2 25A992(E,F)
- ERL1 RL3 2M AP24D2
- ED1,2 IN4148
- ED3,4 IN4003
- ED5 IN4002
- IC1 TA7317P
- 2SA899 2SA1111
- 2SA1209 2SC2591
- 2SB631 2SC1904
- 2SC2911 2SD600
- 2SA1490 2SA1492
- 2SA1492 2SC3854
- 2SA1115 2SA1175
- 2SC3856
- 2SA1349 TA7317P
- M5220L
- DF04M 1N4002
- 1N4003 1N4148
- KBU4D KBU6D
- 0.522.7 0.5215
- RD2.7E RD15E

A	B	C	D
----------	----------	----------	----------

6-3. AU-X201 Power Supply (Primary-side) Section

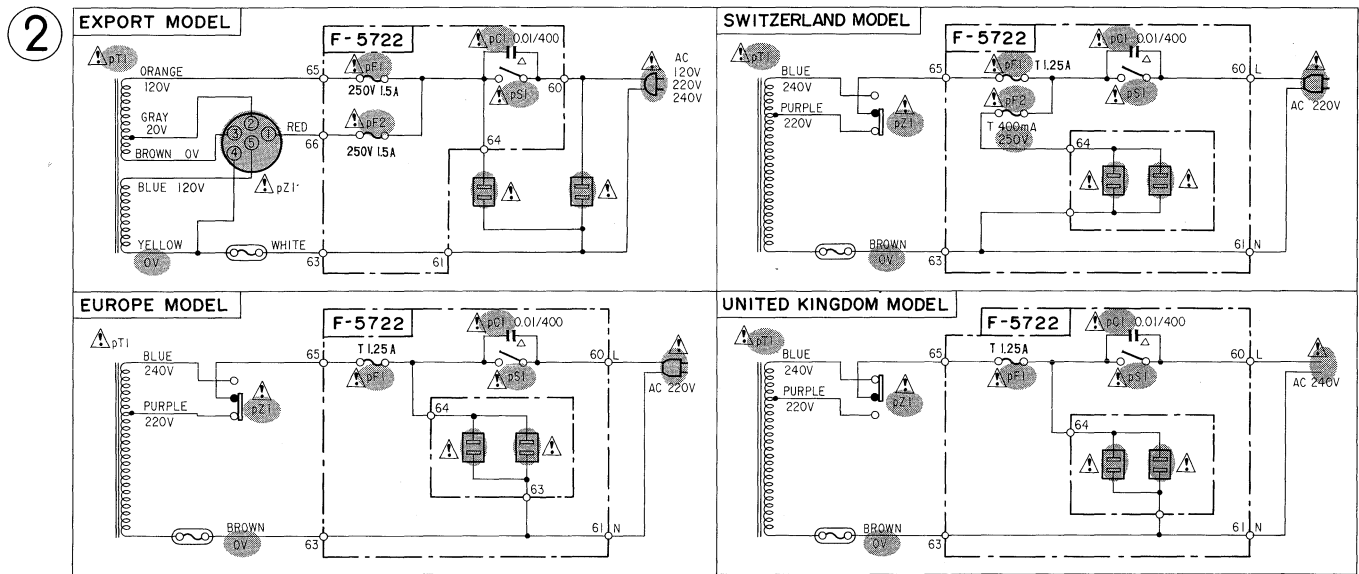

! is Safety part
Use only replacement parts
recommended by the manu-
facturer.

* Design and specifications subject to change without notice for improvement.
* La présentation et les spécifications sont susceptibles d'être modifiées sans préavis par suites d'améliorations éventuelles.
* Änderungen, die dem technischen Fortschritt dienen, bleiben vorbehalten.

6-4. AU-X301 Power Supply (Primary-side) Section

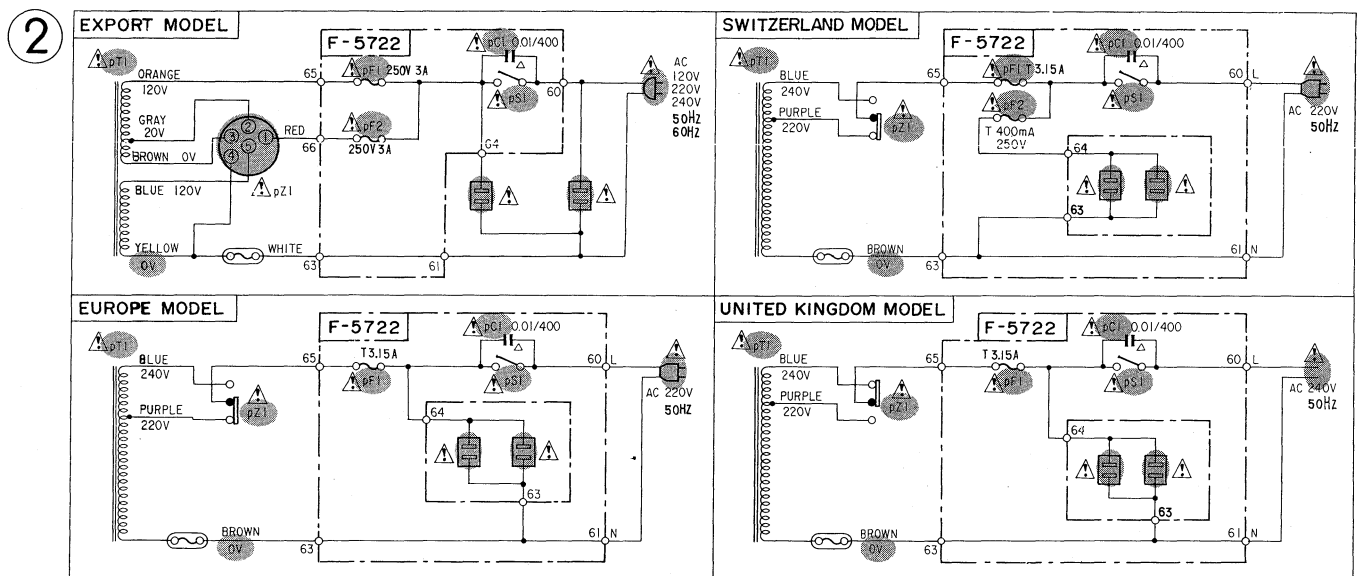

7. PACKING LIST

Parts No.	Stock No.	Description
1	47428000	Polyethylene Sheet
2	47859600	Vinyl Bag
3	84527300	Styrofoam Packing
4	84531700	Carton Case (AU-X201)
	84524300	Carton Case (AU-X301)

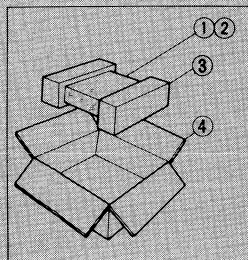

8. ACCESSORY LIST

Stock No.	Description
49025900	Operating Instruction (E•F•S)
49026000	Operating Instruction (G•I•Sw)

Note:

E•F•S: English•French• and Spanish Version

G•I•Sw: German•Italian• and Swedish Version

Sansui

SANSUI ELECTRIC CO., LTD.:

SANSUI ELECTRONICS CORPORATION:

SANSUI ELECTRONICS (U.K.) LTD.:
SANSUI ELECTRONICS G.M.B.H.:

14-1, Izumi 2-chome, Suginami-ku, Tokyo 168 Japan
PHONE: (03) 324-8891/TELEX: 232-2076 (International Division)
1250 Valley Brook Ave. Lyndhurst, N.J. 07071 U.S.A.
17150 South Margay Ave. Carson, California 90746 U.S.A.
3036 Koapaka Street, Honolulu, Hawaii 96819 U.S.A.
Unit 10A, Lyon Industrial Estate, Rockware Avenue, Greenford, Middx UB6. 0AA, England
Paul Ehlich-Strasse 8, 6074 Rödermark 2, West Germany

(SM1-379)

Printed in Japan <Stock No. 36533600>